

CUSTOM INSTALLATION SPEAKERS

FROM LYNGDORF AUDIO



Custom installations with Lyngdorf Audio

Steinway Lyngdorf has a vast experience in designing home cinemas with the outstanding Steinway & Sons loudspeakers and sound processors, while the Lyngdorf MP-40 and MP-60 2.1 multichannel processors set new benchmarks for surround sound and immersive audio. The unique RoomPerfect™ room calibration aligns all speakers and woofers perfectly with each other and adapts the sound to any room.

With the LS-1000, D-500, D-60, D-5 and BW-20 models, Lyngdorf Audio brings its expertise in home cinema and loudspeakers to custom installation speakers. Nine models to suit different installations, from a modern living room with in-wall speakers next to the TV up to the largest home theater with a big screen and immersive audio.

With Lyngdorf Audio you'll experience your favourite movies, games, and music on a new level of sound quality.



D stands for discreet

The D speakers bring Lyngdorf Audio sound quality to the custom installation speaker market. After the successful introduction of Lyngdorf loudspeakers for modern living rooms, ranging from the MH and FR on-wall speakers and BW boundary woofers to the CS-1 cabinet speaker, the Lyngdorf D series expands the company's range with in-wall and in-ceiling speakers for stereo and multichannel installations.

D stands for discreet – all models are designed as installation speakers for discreet in-wall or in-ceiling integration, featuring a wall-fixing mechanism with mounting legs. All models also come with their own loudspeaker enclosure, making system planning and the actual installation as easy as possible, with no after-market backbox or closed wall cavity required. This also ensures that the sound performance is always defined and consistent, depending less on the wall construction and the available space behind the wall.



Lyngdorf D-500
Full-range custom installation in-wall speaker with closed cabinet

Lyngdorf D-60
High-performance custom installation in-wall speaker with closed cabinet



Lyngdorf D-500 Center
Full-range custom installation in-wall center speaker with closed cabinet



Lyngdorf D-60 C
High-performance custom installation in-wall center speaker for bi-amping with closed cabinet



Lyngdorf D-5
Compact and versatile installation in-wall speaker with closed cabinet



Lyngdorf D-5 IC
Compact and versatile installation in-ceiling speaker with angled, adjustable tweeter and closed cabinet



Grills
All Discreet models come with a white, magnetically held and detachable metal grill that fully covers the front

LS-1000 for large home cinemas

With our experience in creating speakers for Steinway Lyngdorf reference home theaters, especially the outstanding Steinway & Sons LS models, combined with our experience from the Lyngdorf MH and FR speakers, our engineers have developed the LS-1000 for Lyngdorf Audio systems. Four LS-1000 modules combined create a line source speaker, with each module consisting of four 115mm midrange drivers with light aluminum cones, 25mm voice coils and powerful vented magnets, complemented by eight 1" soft dome tweeters. Four LS-1000 modules combined result in a line array with 16 midrange drivers and 32 tweeters. Depending on the room width, seat layout, speaker position and screen size, three different LS-1000 models have been designed for the best sound dispersion into the room:

Lyngdorf LS-1000 Center

has the tweeters mounted centered, leading to a wider sound dispersion equal to the left and right. This makes it an ideal choice as Center speaker behind an acoustically transparent screen, or even as left and right speakers to achieve the widest possible listening area in a wide room.

Lyngdorf LS-1000 Left

has a sound dispersion slightly beaming inwards when placed on the left side, away from the sidewall and towards the listening area.

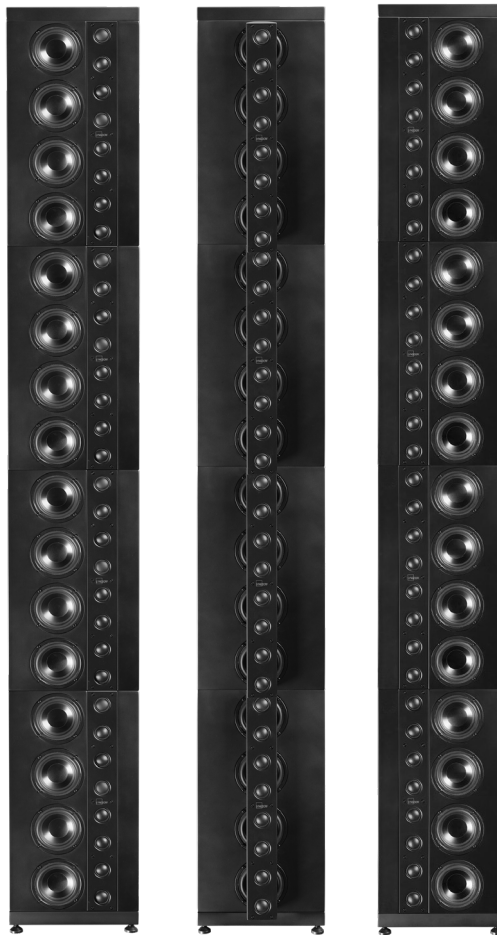

Lyngdorf LS-1000 Right

has a sound dispersion slightly beaming inwards when placed on the right side, away from the sidewall and towards the listening area.

The largest Lyngdorf boundary woofer

The BW-20 complements the Lyngdorf LS and Discreet custom installation speakers, designed for both stereo and multichannel systems. BW stands for Boundary Woofer – a Lyngdorf approach where a sub-woofer is designed to be placed near the wall boundaries, for example right in the corner, achieving the best bass impulse response by avoiding delayed bass bouncing back off the walls, instead taking advantage of room acoustics. The BW-20 is the company's largest BW model, extending the line-up of the compact in-room woofers BW-2 and BW-3.

Two 12" woofers are equipped with vented magnets, double spiders, and aluminum cones, built into a large cabinet volume and a rigid construction. This makes the BW-20 a very capable woofer in any room and system. The woofers are high-excursion designs, reaching an excursion of +/- 20mm and enabling the BW-20 to play the lowest frequencies on a very high volume level, with a max. SPL of 118dB. The BW-20 is a passive design with an IEC power handling of 700W, allowing users to choose an individual power amplifier for the best system match.





Impressive bass from a shallow design

The DW-1 is a high-performance in-wall woofer specifically made for custom installations that require the most shallow woofer solution. The rigid and sealed enclosure is very easy to integrate and perfectly fits 4 inch/10 cm cavity walls, while the extended height provides the large inner cabinet volume required for remarkable bass extension. In combination with a very powerful driver, the DW-1 delivers an impressive bass performance. The DW-1 can be used in-wall floor-standing or custom-mounted in-ceiling and comes with a paintable, magnetically held grill to cover the woofer front.

The very limited depth inside an in-wall woofer requires a special high-performance driver. The DW-1 utilizes a patented high-excursion shallow woofer design, customized for Lyngdorf Audio and based on an innovative voice-coil / cone geometry and suspension, which allows the highest excursion from the most space-saving construction. A four-layer voice coil, an ultra-rigid dual aluminum cone, a very powerful neodymium magnet, and an extremely rigid cast basket provide impressive bass performance, achieving a high output level and low reach. The high-bandwidth design ensures an accurate, fast response and allows the most seamless sound integration with the main speakers.





Specifications

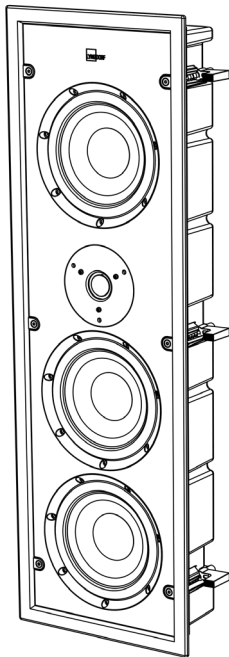

Model: Lyngdorf D-500
Description: 2 way speaker with 2 passive woofers
Tweeter: 28 mm / 1,1" soft dome
Midrange driver: 175 mm, 38 mm voice coil, aluminum cone, vented magnet
Passive woofer: 2 x 175 mm, aluminum cones
Enclosure: Closed compound cabinet
Frequency range: 50 – 22.000 Hz (-3 dB)
Nominal Impedance: 4 Ohm
Sensitivity: 88 dB (2.83V/1m)
Power handling: 100 W (IEC)
Maximum SPL: 105 dB
Crossover point: 2,5 kHz
Connections: Binding posts
Mounting: In-wall
Dimensions with grill (W x H x D): 254 x 779 x 106 mm / 10 x 30.7 x 4.2 inches
Cut-out dimensions (W x H x D): 226 x 751 x 100 mm / 8.9 x 29.6 x 3.9 inches
Weight: 7,4 kg / 16 lb
Finish: Matte black, white grill

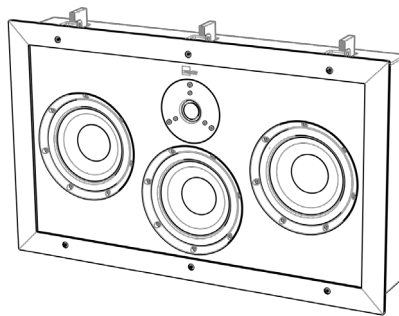

Model: Lyngdorf D-500 Center
Description: 2 way speaker with 2 passive woofers
Tweeter: 28 mm / 1" soft dome
Midrange driver: 175 mm, 38 mm voice coil, aluminum cone, vented magnet
Passive woofers: 2 x 175 mm, aluminum cones
Enclosure: Closed MDF cabinet
Frequency range: 50 – 22.000 Hz (-3 dB)
Nominal Impedance: 4 Ohm
Sensitivity: 88 dB (2.83V/1m)
Power handling: 100 W (IEC)
Maximum SPL: 105 dB
Crossover point: 2,5 kHz
Connections: Binding posts
Mounting: In-wall
Dimensions with grill (W x H x D): 646 x 388 x 109 mm / 25.4 x 15.3 x 4.3 inches
Cut-out dimensions (W x H x D): 618 x 360 x 104 mm / 24.3 x 14.2 x 4.1 inches
Weight: 11,5 kg / 25.4 lb
Finish: Matte black, white grill

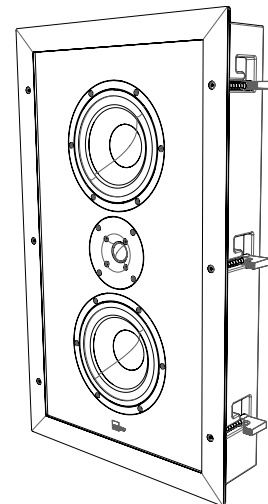

Model: Lyngdorf D-60
Description: Custom installation 2 way speaker
Tweeter: 28 mm / 1" soft dome
Midrange/woofer: 2 x 180 mm, 38 mm voice coil, aluminum cone, vented magnet, die-cast vented basket
Enclosure: Closed MDF cabinet
Frequency range: 80 – 22.000 Hz (-3 dB)
Nominal Impedance: 4 Ohm
Sensitivity: 92 dB (2.83V/1m)
Power handling: 200 W (IEC)
Maximum SPL: 112 dB
Crossover point: 2,5 kHz
Connections: Binding posts
Mounting: In-wall
Dimensions (W x H x D): 388 x 646 x 104 mm / 25.4 x 15.3 x 4.1 inches
Cut-out dimensions (W x H x D): 360 x 618 x 100 mm / 24.3 x 14.2 x 3.9 inches
Weight: 11,4 kg / 25.1 lb
Finish: Matte black, white grill

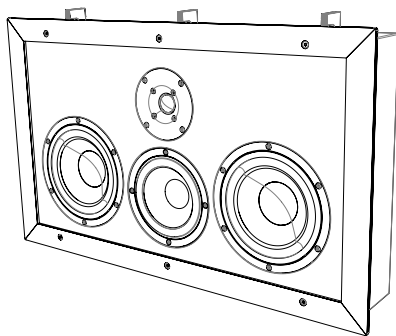

Model: Lyngdorf D-60 C

Description: Custom installation in-wall center and front speaker, for bi-amping

Tweeter: 1 x 28 mm / 1,1" soft dome with large magnet

Midrange/woofer: 1 x 13 cm / 5" with neodymium magnet and 35mm voice coil, 2 x 180 mm, 35 mm voice coil, aluminum cone, vented magnet, die-cast vented basket

Enclosure: Closed MDF cabinet

Frequency range: 80 – 22.000 Hz (-3 dB)

Nominal Impedance: 4 Ohm

Sensitivity: 92 dB (2.83V/1m)

Power handling: 300 W

Maximum SPL: 109 dB

Connections: Push-type spring terminal, gold-plated

Mounting: In-wall

Dimensions (W x H x D): 388 x 646 x 104 mm / 25.4 x 15.3 x 4.1 inches

Cut-out dimensions (W x H x D): 360 x 618 x 100 mm / 24.3 x 14.2 x 3,9 inches

Weight: 13,9 kg / 30.6 lb

Finish: Matte black, white grill

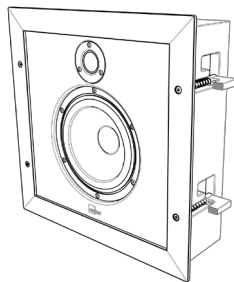

Model: Lyngdorf D-5

Description: 2 way speaker

Tweeter: 25 mm / 1" soft dome

Midrange driver: 180 mm, 35 mm voice coil, aluminum cone, vented magnet

Enclosure: Closed MDF cabinet

Frequency range: 80 - 20,000 Hz (-3 dB)

Nominal Impedance: 4 Ohm

Sensitivity: 89 dB (2.83V/1m)

Power handling: 100 W (IEC)

Maximum SPL: 106 dB

Crossover point: 2,2 kHz

Connections: Binding posts

Mounting: In-wall

Dimensions with grill (W x H x D): 362 x 362 x 109 mm / 14.25 x 14.25 x 4.3 inches

Cut-out dimensions (W x H x D): 334 x 334 x 104 mm / 13.2 x 13.2 x 4.1 inches

Weight: 6,4 kg / 14.1 lb

Finish: Matte black, white grill

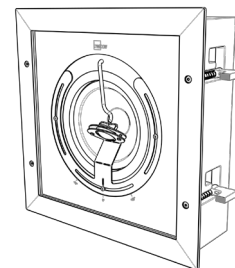

Model: Lyngdorf D-5 IC

Description: 2 way speaker

Tweeter: 25 mm / 1" soft dome

Midrange driver: 180 mm, 35 mm voice coil, aluminum cone, vented magnet

Enclosure: Closed MDF cabinet

Frequency range: 80 - 20,000 Hz (-3 dB)

Nominal Impedance: 4 Ohm

Sensitivity: 88 dB (2.83V/1m)

Power handling: 100 W (IEC)

Maximum SPL: 105 dB

Crossover point: 2,2 kHz

Connections: Binding posts

Mounting: In-ceiling

Dimensions with grill (W x H x D): 362 x 362 x 114 mm / 14.25 x 14.25 x 4.5 inches

Cut-out dimensions (W x H x D): 334 x 334 x 109 mm / 13.2 x 13.2 x 4.3 inches

Weight: 6,9 kg / 15.2 lb

Finish: Matte black, white grill

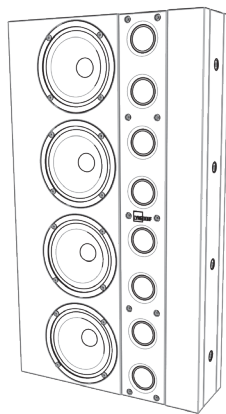

Model: Lyngdorf LS-1000 Left
Description: 2-way line source, closed
Tweeter: 8 pcs 1" soft dome
Midrange driver: 4 pcs 115 mm, 25mm voice coil, aluminum cone, vented magnet
Enclosure: MDF
Frequency range: 100 – 20.000 Hz (-3 dB) (for four LS-1000 modules)
Frequency extension down to 50 Hz depending on EQ
Nominal Impedance: 4 Ohm (for four LS-1000 modules) (16 Ohm per module)
Sensitivity: 98 dB (2.83 V/1 m) (for four LS-1000 modules)
Power handling: 300 W (IEC) (for four LS-1000 modules)
Maximum SPL: 120 dB (for four LS-1000 modules)
Crossover point: 1,8 kHz
Connections: Screw terminals
Mounting: In-wall
Dimensions (W x H x D): 280 x 500 x 85 mm / 11 x 19.7 x 3.35 inches + mounting
Weight: 9,9 kg / 21.8 lb
Finish: Matte black

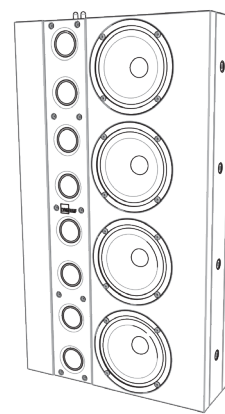

Model: Lyngdorf LS-1000 Right
Description: 2-way line source, closed
Tweeter: 8 pcs 1" soft dome
Midrange driver: 4 pcs 115 mm, 25mm voice coil, aluminum cone, vented magnet
Enclosure: MDF
Frequency range: 100 – 20.000 Hz (-3 dB) (for four LS-1000 modules)
Frequency extension down to 50 Hz depending on EQ
Nominal Impedance: 4 Ohm (for four LS-1000 modules) (16 Ohm per module)
Sensitivity: 98 dB (2.83 V/1 m) (for four LS-1000 modules)
Power handling: 300 W (IEC) (for four LS-1000 modules)
Maximum SPL: 120 dB (for four LS-1000 modules)
Crossover point: 1,8 kHz
Connections: Screw terminals
Mounting: In-wall
Dimensions (W x H x D): 280 x 500 x 85 mm / 11 x 19.7 x 3.35 inches + mounting
Weight: 9,9 kg / 21.8 lb
Finish: Matte black

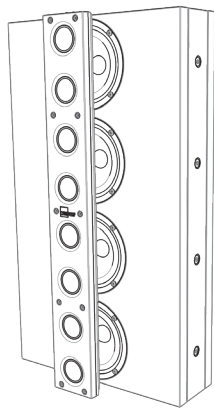

Model: Lyngdorf LS-1000 Center

Description: 2-way line source, closed

Tweeter: 8 pcs 1" soft dome

Midrange driver: 4 pcs 115 mm, 25mm voice coil, aluminum cone, vented magnet

Enclosure: MDF

Frequency range: 100 – 20.000 Hz (-3 dB) (for four LS-1000 modules)

Frequency extension down to 50 Hz depending on EQ

Nominal Impedance: 4 Ohm (for four LS-1000 modules)
(16 Ohm per module)

Sensitivity: 98 dB (2.83 V/1 m) (for four LS-1000 modules)

Power handling: 300 W (IEC) (for four LS-1000 modules)

Maximum SPL: 120 dB (for four LS-1000 modules)

Crossover point: 1,8 kHz

Connections: Screw terminals

Mounting: In-wall

Dimensions (W x H x D): 280 x 500 x 132 mm /
11 x 19.7 x 5.2 inches + mounting

Weight: 10,4 kg / 22.9 lb

Finish: Matte black

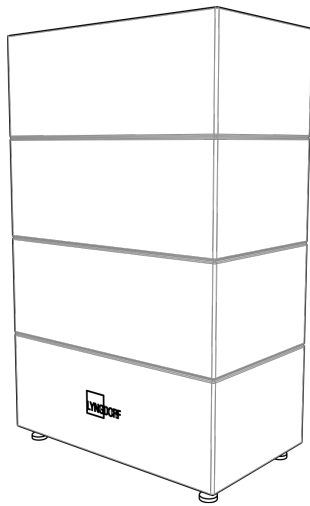

Model: Lyngdorf BW-20

Description: Passive boundary woofer, closed

Woofers: Two 12" long throw +/- 20mm, 67mm voice coil, aluminum cone, double spider, vented magnet

Enclosure: MDF, closed 64 L net

Frequency range: 19 – 500 Hz (-3 dB)
Frequency extension depending on EQ

Nominal Impedance: 4 Ohm

Power handling: 700 W (IEC)

Maximum SPL: 118 dB

Connections: Neutrik speakON

Mounting: Floor standing

Dimensions (W x H x D): 450 x 710 x 270 mm /
17.7 x 28 x 10.6 inch
(Cabinet without spike feet and woofer excursion)

Weight: 35 kg / 77 lb

Finish: Matte black

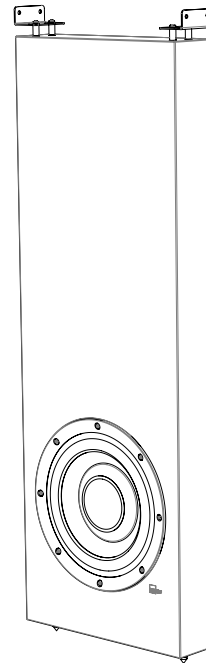

Model: Lyngdorf BW-20

Description: Passive in-wall woofer

Woofers: 1 x 10-inch, dual aluminum cone, 4-layer voice coil, neodymium magnet

Enclosure: MDF with internal bracing, 19 mm and 16 mm

Frequency range: 30 – 200 Hz (-3 dB)

Nominal Impedance: 4 Ohm

Power handling: 300 W

Maximum SPL: 109 dB (60 V / 1 m)

Sensitivity: 82 dB (2.83 V / 1 m)

Connections: Push-type spring terminal, gold-plated
Recommended placement: In-wall floor-standing,
boundary woofer

Dimensions (W x H x D): 350 x 1000 x 88 mm / 13,78
x 39,4 x 3,5 inches

Weight: 16 kg / 35,3 lbs

Finish: Matte black, paintable front grill

